

High Voltage LED Series Chip on Board

LCo40B Gen.2



High efficacy COB LED package,
well-suited for use in spotlight applications

Features & Benefits

- Chip on Board (COB) solution makes it easy to design in
- Simple assembly reduces manufacturing cost
- Low thermal resistance
- InGaN/GaN MQW LED with long time reliability
- Completed 6,000 hours of LM-80 Testing

Applications

- Spotlight / Downlight
- LED Retrofit Bulbs
- Outdoor Illumination



Table of Contents

1.	Characteristics	-----	3
2.	Product Code Information	-----	6
3.	Typical Characteristics Graphs	-----	13
4.	Outline Drawing & Dimension	-----	18
5.	Reliability Test Items & Conditions	-----	19
6.	Label Structure	-----	20
7.	Packing Structure	-----	22
8.	Precautions in Handling & Use	-----	25

1. Characteristics

a) Absolute Maximum Rating

Item	Symbol	Rating	Unit	Condition
Ambient / Operating Temperature	T_a	-40 ~ +105	°C	-
Storage Temperature	T_{stg}	-40 ~ +120	°C	-
LED Junction Temperature	T_j	150	°C	-
Case Temperature	T_c	105	°C	*Note
Forward Current	I_F	1900	mA	-
Power Dissipation	P_D	70.3	W	-
ESD (HBM)	-	±2	kV	-
ESD (MM)	-	±0.5	kV	-

b) Electro-optical Characteristics ($I_F = 1080 \text{ mA}$, $T_c = 25 \text{ °C}$)

Item	Unit	Rank	Min.	Typ.	Max.
Forward Voltage (V_F)	V	YH	32.5	35.5	38.5
Color Rendering Index (R_a)	-	3	70	-	-
		5	80 ($R_9 > 0$)	-	-
		7	90	-	-
		8	95	-	-
		Thermal Resistance (junction to chip point)	°C/W	-	-
Beam Angle	°	-	-	115	-
Nominal Power	W	-	-	38.3	-

Notes:

- 1) The COB is tested in pulsed condition at rated test current (10 ms pulse width) and rated temperature ($T_j = T_c = T_a = 25 \text{ °C}$)
- 2) Samsung maintains measurement tolerance of: forward voltage = $\pm 5 \%$, CRI = ± 1
- 3) Refer to the derating curve, '3. Typical Characteristics Graph' designed within the range.

c) Luminous Flux Characteristics ($I_F = 1080 \text{ mA}$)

CRI (R _a) Min.	Nominal CCT (K)	Flux Rank	Flux Bin	Sorting ¹⁾ @ T _c = 25 °C (lm)		Calculated Flux ²⁾ @ T _c = 85 °C (lm)	
				Min.	Max.	Min.	Max.
70	3000	4J	41	4776	5428	4299	4885
			42	5428	6079	4885	5471
	4000	4J	41	5063	5753	4557	5178
			42	5753	6444	5178	5799
	5000	5J	51	5111	5808	4600	5227
			52	5808	6505	5227	5854
80	2700	4G	45	5100	5450	4641	4960
			46	5450	5800	4960	5278
		4H	46	5450	5800	4960	5278
	3000	4G	45	5255	5615	4782	5110
			46	5615	5975	5110	5437
		4H	46	5615	5975	5110	5437
	3500	4G	44	5100	5480	4641	4987
			45	5480	5860	4987	5333
		4H	45	5480	5860	4987	5333
	4000	4G	44	5245	5635	4773	5128
			45	5635	6025	5128	5483
		4H	45	5635	6025	5128	5483
	5000	4G	44	5295	5690	4818	5178
			45	5690	6085	5178	5537
		4H	45	5690	6085	5178	5537
	5700	4G	44	5295	5690	4818	5178
			45	5690	6085	5178	5537
		4H	45	5690	6085	5178	5537
90	2700	4K	44	4126	4456	3754	4055
			45	4459	4906	4055	4464
	3000	4K	44	4210	4546	3831	4137
			45	4546	4996	4137	4547
	3500	4K	44	4336	4683	3946	4261
			45	4683	5133	4261	4671
4000	4K	44	4462	4819	4061	4386	
		45	4819	5269	4386	4795	
95	2700	3M	31	3394	3771	3088	3432
			32	3771	4148	3432	3775
	3000	3M	31	3499	3888	3184	3538
			32	3888	4276	3538	3892
	3500	3M	31	3604	4004	3280	3644
			32	4004	4405	3644	4008

Notes:

- 1) The COB is tested in pulsed condition at rated test current (10 ms pulse width) and rated temperature ($T_j = T_c = T_a = 25 \text{ °C}$)
- 2) Calculated flux values are for reference only
- 3) Samsung maintains measurement tolerance of: luminous flux = $\pm 7 \%$, CRI = ± 1

2. Product Code Information

1	2	3	4	5	6	7	8	9	10	11	12	13	14	15	16	17	18
S	P	H	C	W	1	H	D	N	E	2	5	Y	H	R	T	4	J

Digit	PKG Information	Code	Specification
1 2 3	Samsung Package High Power	SPH	
4 5	Color	WW CW	Warm White (T/U/V/W Ranks) Cool White (Q/R Ranks)
6	Product Version	1	
7 8	Form Factor	HD	COB
9	Lens Type	N	No lens
10	Internal Code	E	LC040
11	Chip Type	2	
12	CRI & Sorting Temperature	3 5 7 8	Min. 70 Min. 80 Min. 90 Min 95 25 °C
13 14	Forward Voltage (V)	YH	32.5~38.5
15	CCT (K)	W V U T R Q	2700 K 3000 K 3500 K 4000 K 5000 K 5700 K WA, WB (MacAdam Ellipse) VA, VB (MacAdam Ellipse) UA, UB (MacAdam Ellipse) TA, TB (MacAdam Ellipse) RA (MacAdam Ellipse) Bin Code: VW, VX, VY, VZ (ANSI bin) TW, TX, TY, TZ (ANSI bin) RW, RX, RY, RZ (ANSI bin) QW, QX, QY, QZ (ANSI bin)
16	MacAdam / ANSI	2 3 T	MacAdam 2-step MacAdam 3-step ANSI bin
17 18	Luminous Flux	3M 4J 4G 4H 4K 5J	31, 32 (95 CRI) 41, 42 (70 CRI) 44, 45, 46 (80 CRI) 45, 46 (80 CRI) 44, 45 (90 CRI) 51, 52 (70 CRI) Bin Code:

a) Binning Structure ($I_F = 1080 \text{ mA}$, $T_c = 25 \text{ }^\circ\text{C}$)

CRI (R_a) Min.	Nominal CCT (K)	Product Code	V_F Rank	Color Rank	Chrom. Bin	Flux Rank	Flux Bin	Flux Range (Φ_v, lm)		
70	3000	SPHWW1HDNE23YHVT4J	YH	VT	VW, VX VY, VZ	4J	41	4776 ~ 5428		
							42	5428 ~ 6079		
	4000	SPHWW1HDNE23YHTT4J	YH	TT	TW, TX TY, TZ	4J	41	5063 ~ 5753		
							42	5753 ~ 6444		
	5000	SPHCW1HDNE23YHRT5J	YH	RT	RW, RX RY, RZ	5J	51	5111 ~ 5808		
							52	5808 ~ 6505		
80	2700	SPHWW1HDNE25YHW24G	YH	W2	WB	4G	45	5100 ~ 5450		
							46	5450 ~ 5800		
	2700	SPHWW1HDNE25YHW34G	YH	W3	WA, WB	4G	45	5100 ~ 5450		
							46	5450 ~ 5800		
		SPHWW1HDNE25YHW24H	YH	W2	WB	4H	46	5450 ~ 5800		
							46	5450 ~ 5800		
		SPHWW1HDNE25YHW34H	YH	W3	WA, WB	4H	46	5450 ~ 5800		
							46	5450 ~ 5800		
	3000	2700	SPHWW1HDNE25YHV24G	YH	V2	VB	4G	45	5255 ~ 5615	
								46	5615 ~ 5975	
		3000	SPHWW1HDNE25YHV34G	YH	V3	VA, VB	4G	45	5255 ~ 5615	
								46	5615 ~ 5975	
			SPHWW1HDNE25YHV24H	YH	V2	VB	4H	46	5615 ~ 5975	
								46	5615 ~ 5975	
		SPHWW1HDNE25YHV34H	YH	V3	VA, VB	4H	46	5615 ~ 5975		
							46	5615 ~ 5975		
	3500	2700	SPHWW1HDNE25YHU24G	YH	U2	UB	4G	44	5100 ~ 5480	
								45	5480 ~ 5860	
		3500	SPHWW1HDNE25YHU34G	YH	U3	UA, UB	4G	44	5100 ~ 5480	
								45	5480 ~ 5860	
			SPHWW1HDNE25YHU24H	YH	U2	UB	4H	45	5480 ~ 5860	
								45	5480 ~ 5860	
			SPHWW1HDNE25YHU34H	YH	U3	UA, UB	4H	45	5480 ~ 5860	
								45	5480 ~ 5860	
		4000	2700	SPHWW1HDNE25YHT24G	YH	T2	TB	4G	44	5245 ~ 5635
									45	5635 ~ 6025
			4000	SPHWW1HDNE25YHT34G	YH	T3	TA, TB	4G	44	5245 ~ 5635
									45	5635 ~ 6025
			SPHWW1HDNE25YHT24H	YH	T2	TB	4H	45	5635 ~ 6025	
								45	5635 ~ 6025	
	SPHWW1HDNE25YHT34H	YH	T3	TA, TB	4H	45	5635 ~ 6025			
						45	5635 ~ 6025			
5000	2700	SPHCW1HDNE25YHR34G	YH	R3	RA	4G	44	5295 ~ 5690		
							45	5690 ~ 6085		
	5000	SPHCW1HDNE25YHRT4G	YH	RT	RW, RX RY, RZ	4G	44	5295 ~ 5690		
							45	5690 ~ 6085		
		SPHCW1HDNE25YHR34H	YH	R3	RA	4H	45	5690 ~ 6085		
							45	5690 ~ 6085		
	SPHCW1HDNE25YHRT4H	YH	RT	RW, RX RY, RZ	4H	45	5690 ~ 6085			
						45	5690 ~ 6085			
5700	2700	SPHCW1HDNE25YHQT4G	YH	QT	QW, QX QY, QZ	4G	44	5295 ~ 5690		
							45	5690 ~ 6085		
	SPHCW1HDNE25YHQT4H	YH	QT	QW, QX QY, QZ	4H	45	5690 ~ 6085			
						45	5690 ~ 6085			

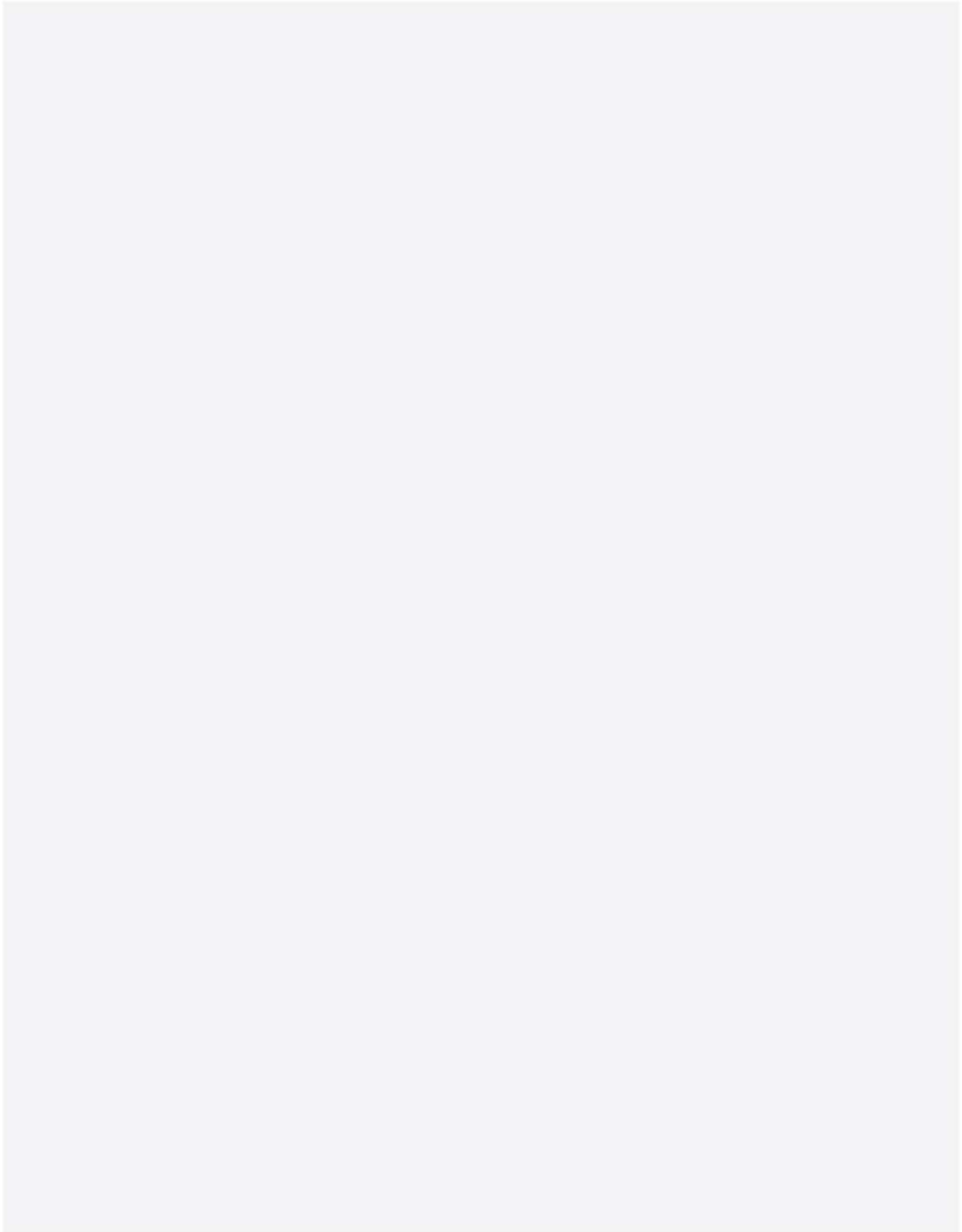

a) Binning Structure ($I_F = 1080 \text{ mA}$, $T_c = 25 \text{ }^\circ\text{C}$)

CRI (R _a) Min.	Nominal CCT (K)	Product Code	V _F Rank	Color Rank	Chrom. Bin	Flux Rank	Flux Bin	Flux Range (Φ _v , lm)		
90	2700	SPHWW1HDNE27YHW24K	YH	W2	WB	4K	44	4126 ~ 4456		
							45	4456 ~ 4906		
		SPHWW1HDNE27YHW34K	YH	W3	WA,WB	4K	44	4126 ~ 4456		
							45	4456 ~ 4906		
		3000	SPHWW1HDNE27YHV24K	YH	V2	VB	4K	44	4210 ~ 4546	
								45	4546 ~ 4996	
	SPHWW1HDNE27YHV34K		YH	V3	VA,VB	4K	44	4210 ~ 4546		
							45	4546 ~ 4996		
	3500		SPHWW1HDNE27YHU24K	YH	U2	UB	4K	44	4336 ~ 4683	
								45	4683 ~ 5133	
		SPHWW1HDNE27YHU34K	YH	U3	UA,UB	4K	44	4336 ~ 4683		
							45	4683 ~ 5133		
		4000	SPHWW1HDNE27YHT24K	YH	T2	TB	4K	44	4462 ~ 4819	
								45	4819 ~ 5269	
	SPHWW1HDNE27YHT34K		YH	T3	TA,TB	4K	44	4462 ~ 4819		
							45	4819 ~ 5269		
	95		2700	SPHWW1HDNE28YHW23M	YH	W2	WB	3M	31	3394 ~ 3771
									32	3771 ~ 4148
SPHWW1HDNE28YHW33M		YH		W3	WA,WB	3M	31	3394 ~ 3771		
							32	3771 ~ 4148		
3000		SPHWW1HDNE28YHV23M		YH	V2	VB	3M	31	3499 ~ 3888	
								32	3888 ~ 4276	
		SPHWW1HDNE28YHV33M	YH	V3	VA,VB	3M	31	3499 ~ 3888		
							32	3888 ~ 4276		
		3500	SPHWW1HDNE28YHU23M	YH	U2	UB	3M	31	3604 ~ 4004	
								32	4004 ~ 4405	
SPHWW1HDNE28YHU33M			YH	U3	UA,UB	3M	31	3604 ~ 4004		
							32	4004 ~ 4405		

b) Chromaticity Region & Coordinates ($I_F = 1080 \text{ mA}$, $T_a = 25 \text{ }^\circ\text{C}$)

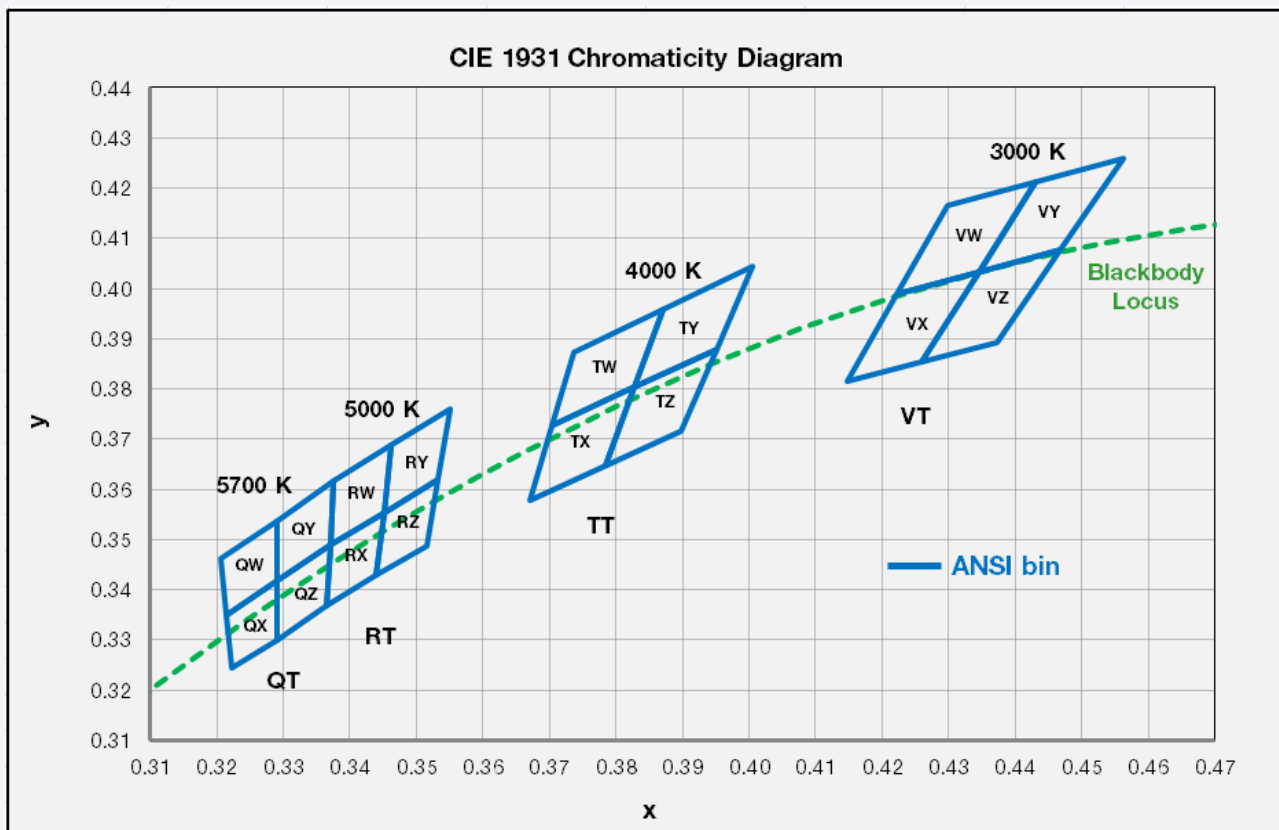

Region	CIE x	CIE y	Region	CIE x	CIE y
V rank (3000 K)					
VW	0.4223	0.399	VY	0.4345	0.4033
	0.4345	0.4033		0.4468	0.4077
	0.4431	0.4213		0.4562	0.4260
	0.4299	0.4165		0.4431	0.4213
VX	0.4223	0.399	VZ	0.4260	0.3854
	0.4147	0.3814		0.4373	0.3893
	0.4260	0.3854		0.4468	0.4077
	0.4345	0.4033		0.4345	0.4033
R rank (5000 K)					
RW	0.3376	0.3616	RY	0.3463	0.3687
	0.3463	0.3687		0.3551	0.3760
	0.3451	0.3554		0.3533	0.3620
	0.3371	0.3490		0.3451	0.3554
RX	0.3371	0.3490	RZ	0.3451	0.3554
	0.3451	0.3554		0.3533	0.3620
	0.3440	0.3428		0.3515	0.3487
	0.3366	0.3369		0.3440	0.3428

Region	CIE x	CIE y	Region	CIE x	CIE y
T rank (4000 K)					
TW	0.3736	0.3874	TY	0.3871	0.3959
	0.3871	0.3959		0.4006	0.4044
	0.3828	0.3803		0.3952	0.388
	0.3703	0.3726		0.3828	0.3803
TX	0.3703	0.3726	TZ	0.3828	0.3803
	0.3828	0.3803		0.3952	0.388
	0.3784	0.3647		0.3898	0.3716
	0.367	0.3578		0.3784	0.3647
Q rank (5700 K)					
QW	0.3207	0.3462	QY	0.3290	0.3538
	0.3290	0.3538		0.3376	0.3616
	0.3290	0.3417		0.3371	0.3490
	0.3215	0.3350		0.3290	0.3417
QX	0.3215	0.3350	QZ	0.3290	0.3417
	0.3290	0.3417		0.3371	0.3490
	0.3290	0.3300		0.3366	0.3369
	0.3222	0.3243		0.3290	0.3300

b) Chromaticity Region & Coordinates ($I_F = 1080 \text{ mA}$, $T_a = 25 \text{ }^\circ\text{C}$)

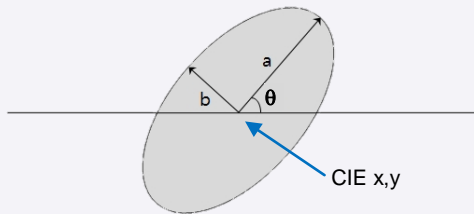
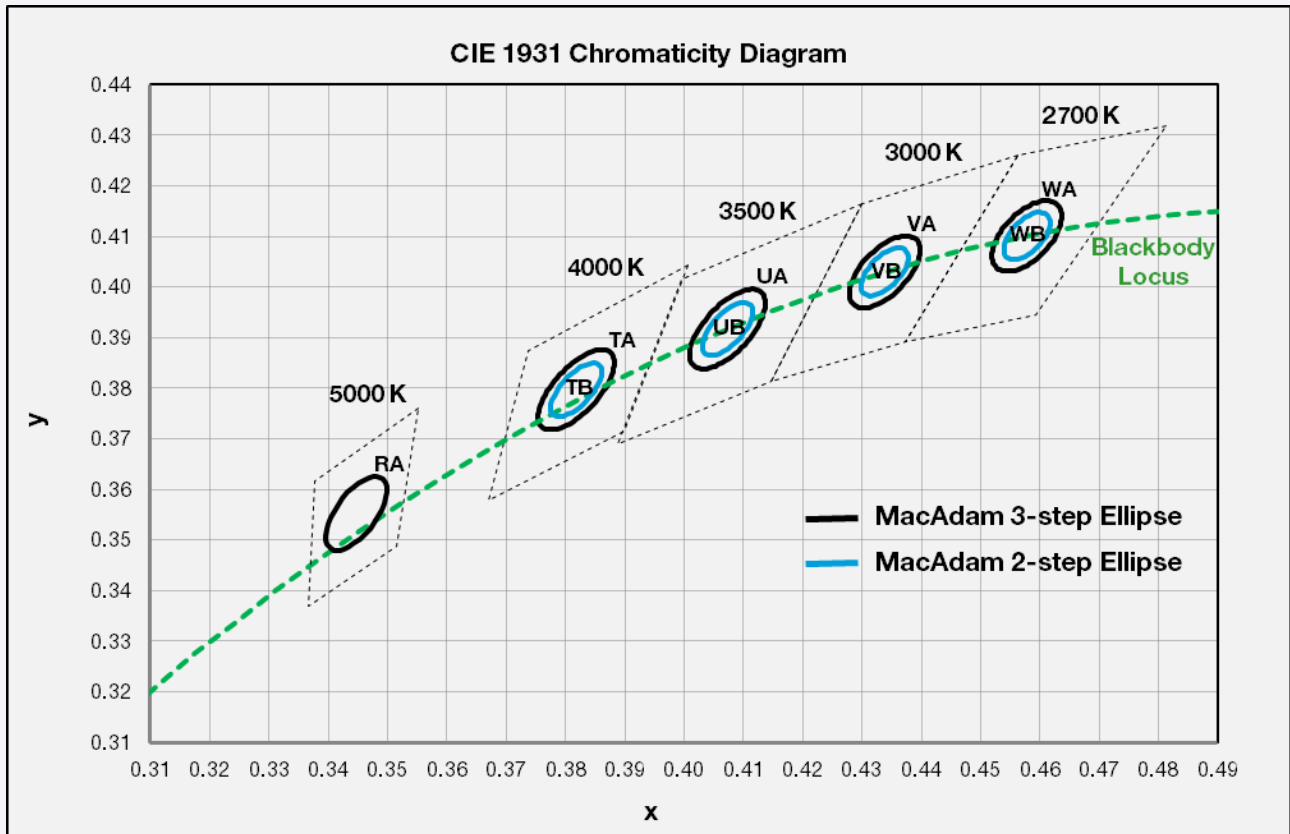

MacAdam Ellipse (WA, WB)					
Step	CIE x	CIE y	θ	a	b
2-step	0.4578	0.4101	53.70	0.0054	0.0028
3-step	0.4578	0.4101	53.70	0.0081	0.0042

MacAdam Ellipse (VA, VB)					
Step	CIE x	CIE y	θ	a	b
2-step	0.4338	0.403	53.22	0.0056	0.0027
3-step	0.4338	0.4030	53.22	0.0083	0.0041

MacAdam Ellipse (UA, UB)					
Step	CIE x	CIE y	θ	a	b
2-step	0.4073	0.3917	54.00	0.0062	0.0028
3-step	0.4073	0.3917	54.00	0.0093	0.0041

MacAdam Ellipse (TA, TB)					
Step	CIE x	CIE y	θ	a	b
2-step	0.3818	0.3797	53.72	0.0063	0.0027
3-step	0.3818	0.3797	53.72	0.0094	0.0040

MacAdam Ellipse (RA)					
Step	CIE x	CIE y	θ	a	b
3-step	0.3447	0.3553	59.62	0.0082	0.0035

Note:

Samsung maintains measurement tolerance of: $C_x, C_y = \pm 0.005$



3. Typical Characteristics Graphs

a) Spectrum Distribution ($I_F = 1080 \text{ mA}$, $T_c = 25 \text{ }^\circ\text{C}$)

CCT: 2700 K (80 CRI)

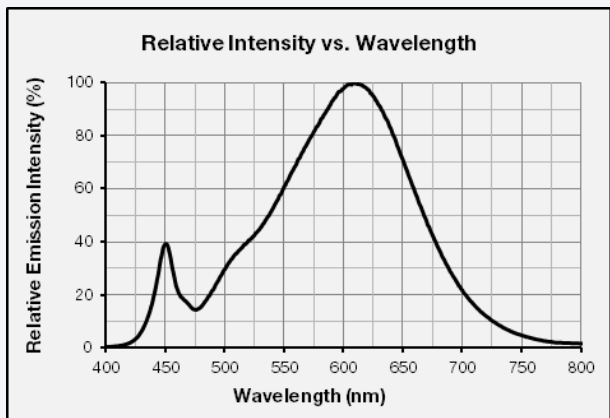

CCT: 3000 K (80 CRI)

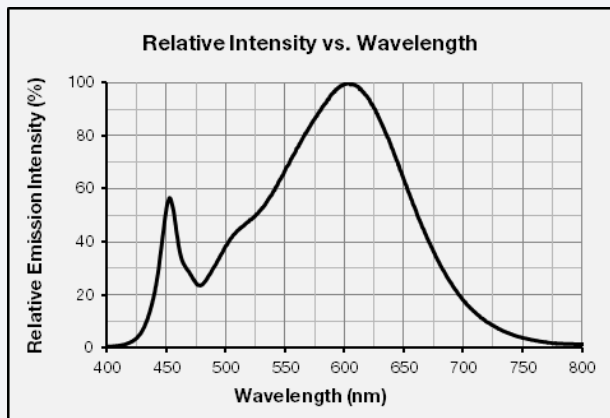

CCT: 3500 K (80 CRI)

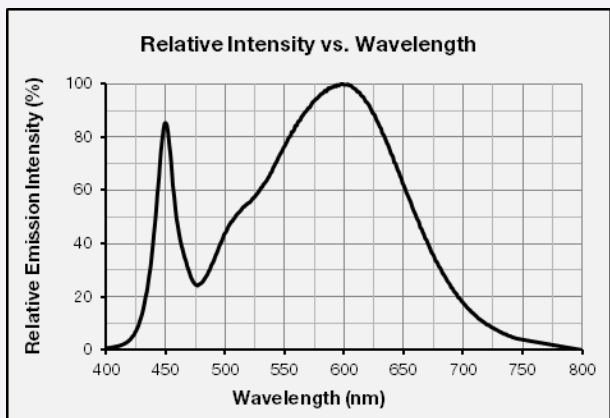

CCT: 4000 K (80 CRI)

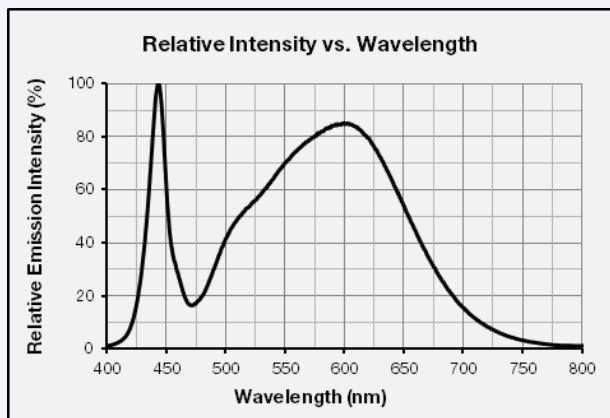

CCT: 5000 K (80 CRI)

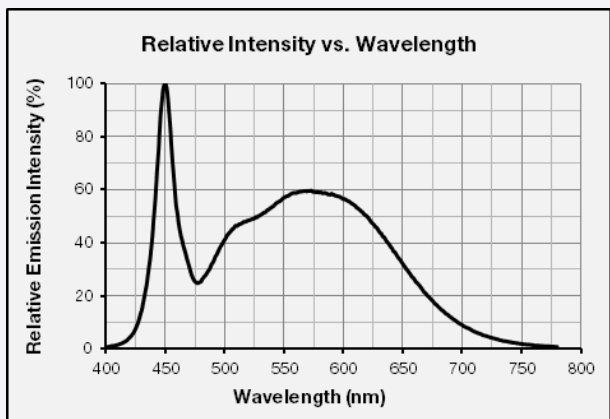

CCT: 5700 K (80 CRI)

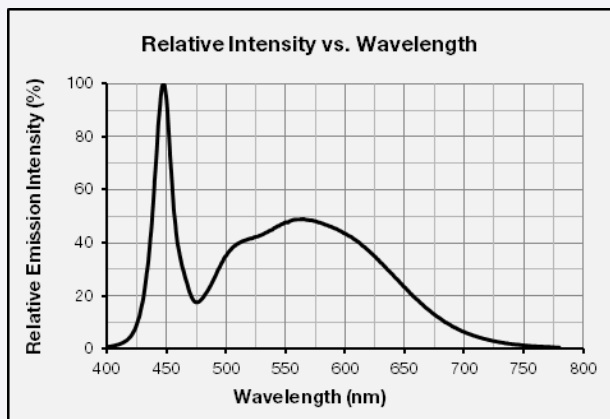

CCT: 2700 K (90 CRI)

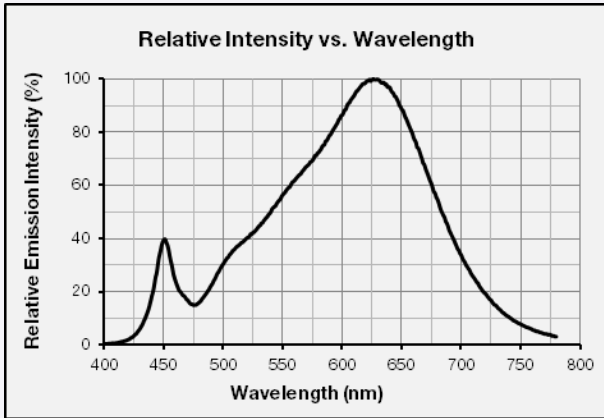

CCT: 3000 K (90 CRI)

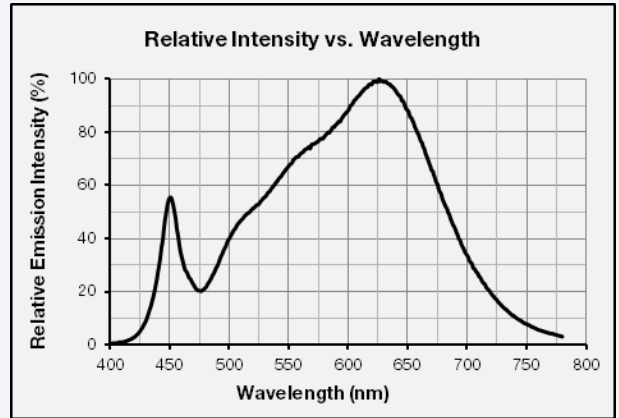

CCT: 3500 K (90 CRI)

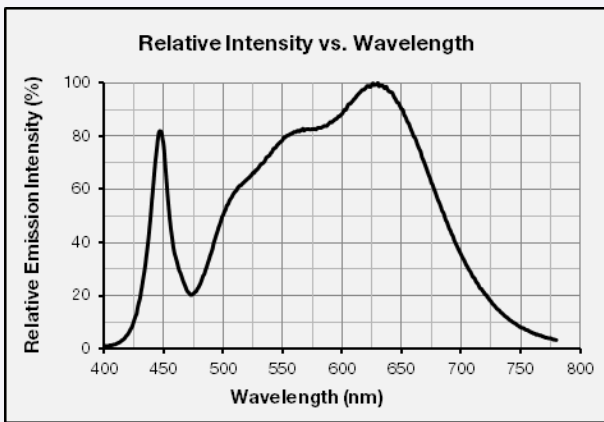

CCT: 4000 K (90 CRI)

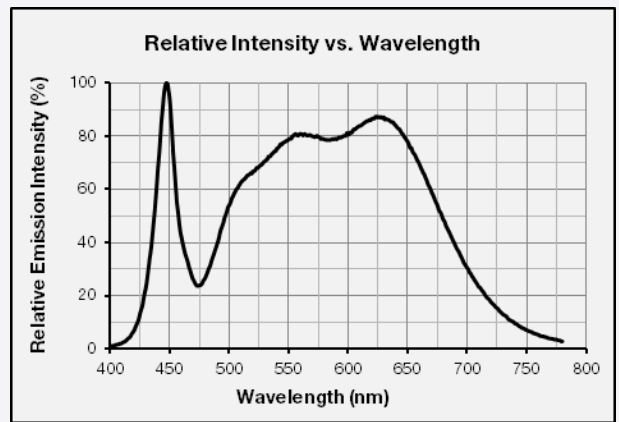

b) Forward Current Characteristics (T_c = 25 °C)

80 CRI

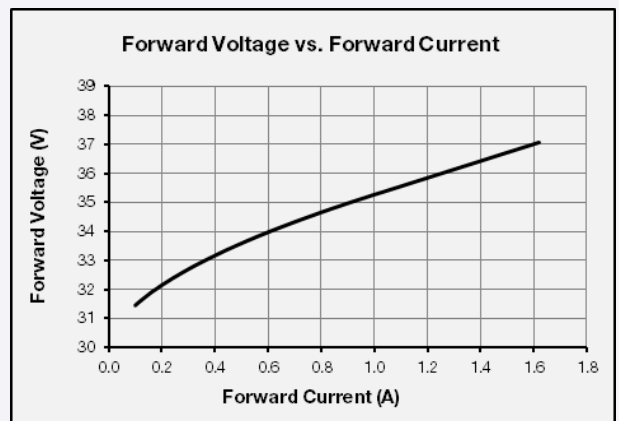
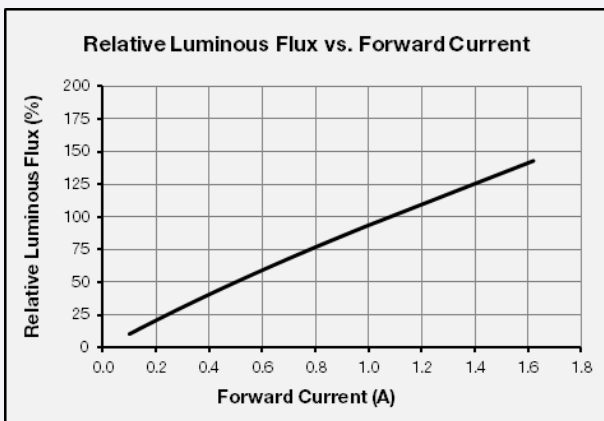

90 CRI

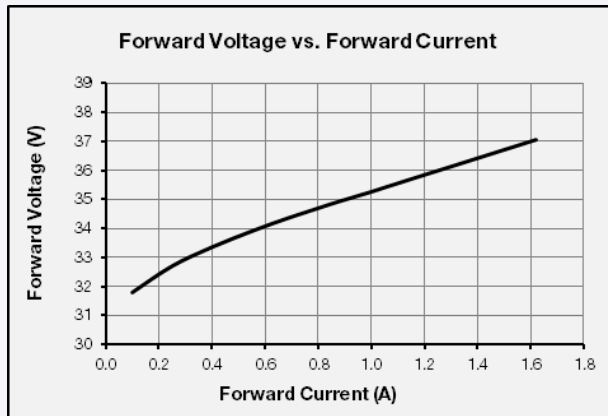
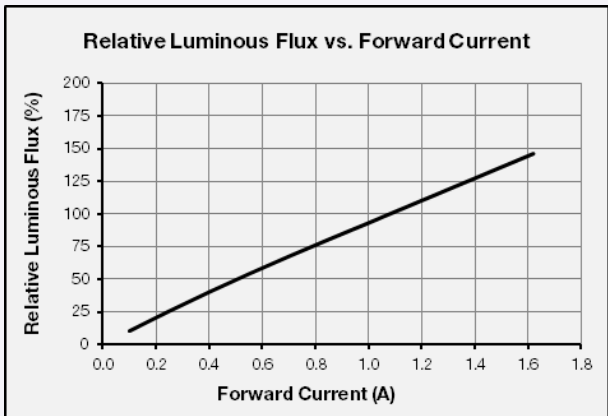

c) Temperature Characteristics (I_F = 1080 mA)

80 CRI

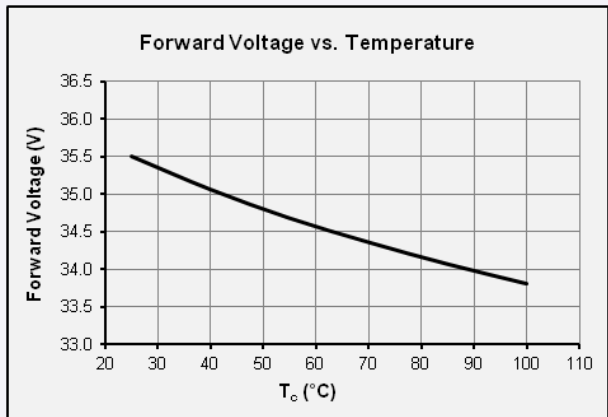
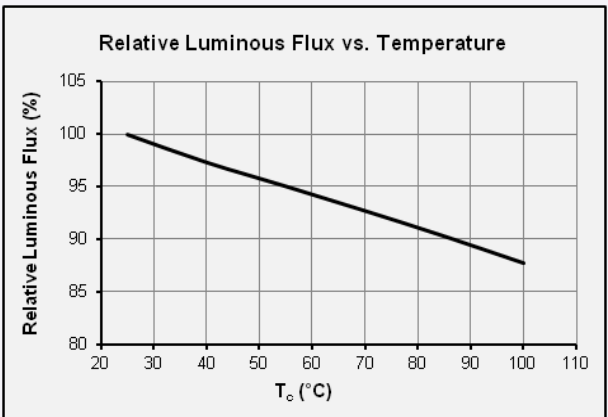

90 CRI

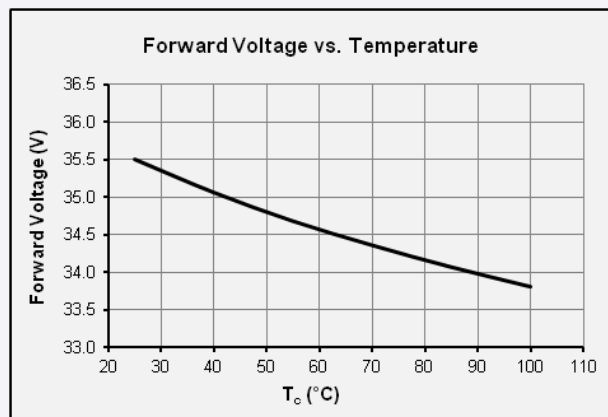
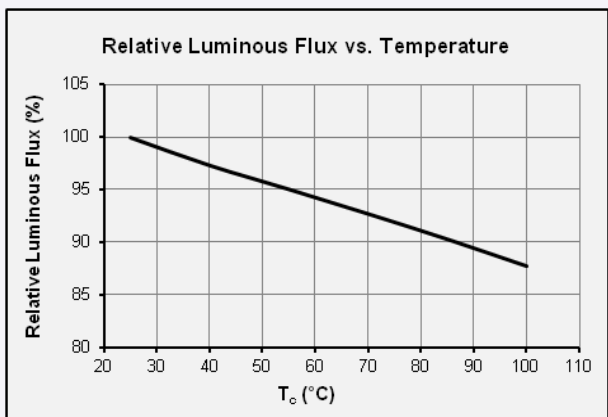

d) Color Shift Characteristics

$T_c = 25\text{ }^\circ\text{C}$

$I_F = 1080\text{ mA}$

80 CRI

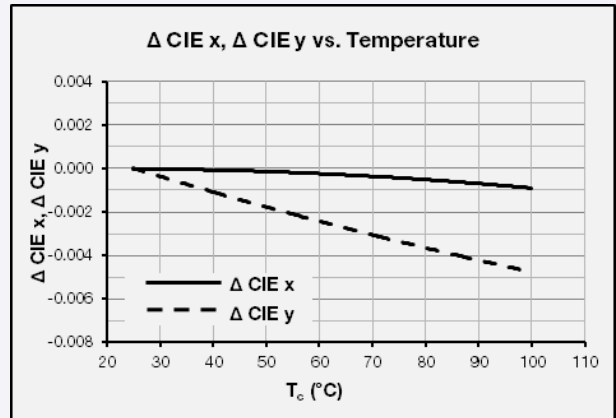
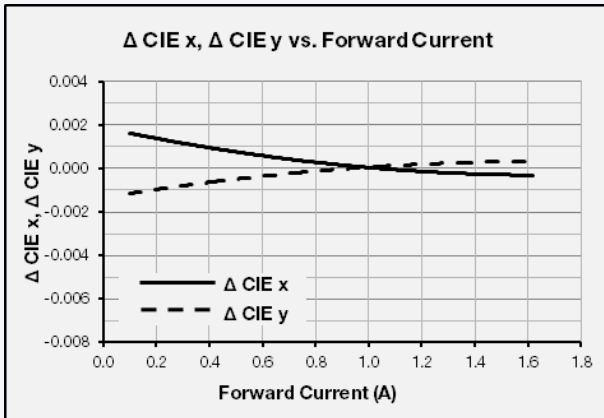

90 CRI

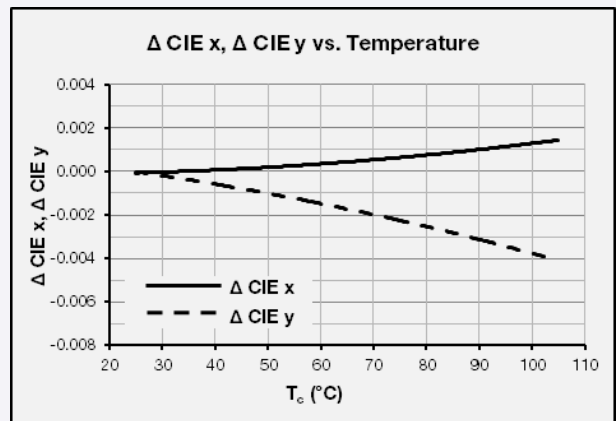
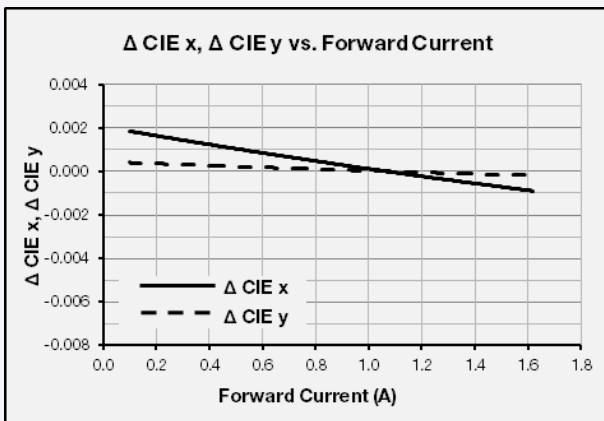

e) Derating Curve

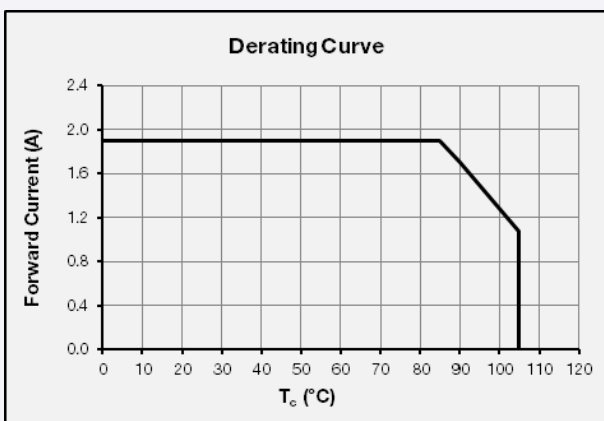

f) Beam Angle Characteristics ($I_F = 1080 \text{ mA}$, $T_c = 25 \text{ }^\circ\text{C}$)

80 CRI

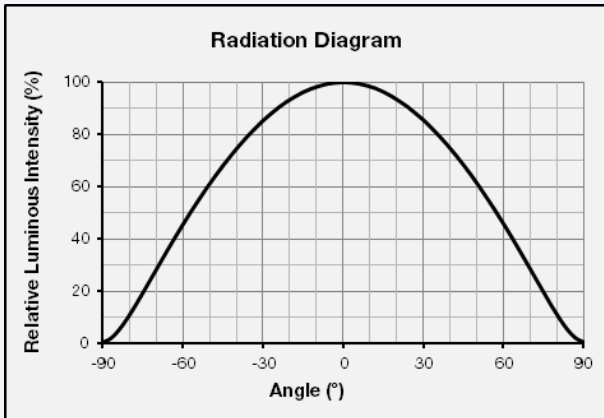

90 CRI

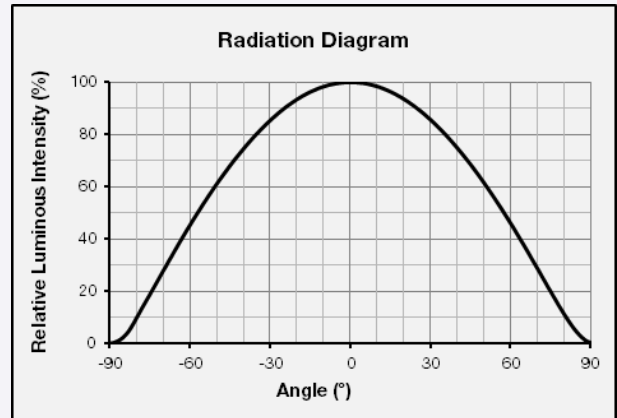

4. Outline Drawing & Dimension

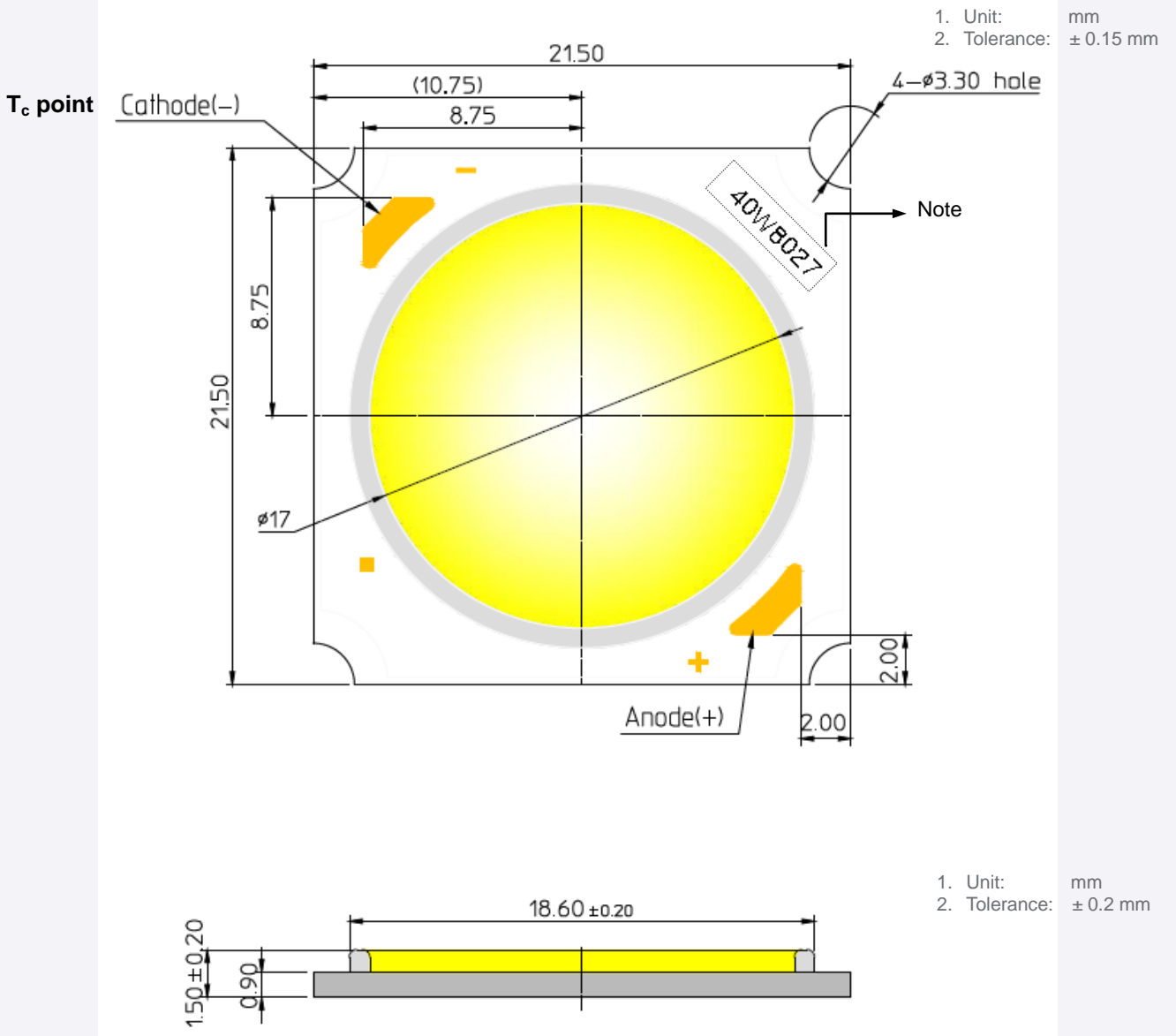

Item	Dimension	Tolerance	Unit
Length	21.50	± 0.15	mm
Width	21.50	± 0.15	mm
Height	1.50	± 0.20	mm
Light Emitting Surface (LES) Diameter	17	± 0.15	mm

Note: Denoted product information above is only an example
(40W8027 : 40W, CRI80+, 2700K)



5. Reliability Test Items & Conditions

a) Test Items

Test Item	Test Condition	Test Hour / Cycle
Room Temperature Life Test	25 °C, $I_F = \max$	1000 h
High Temperature Humidity Life Test	85 °C, 85 % RH, DC Derating, $I_F = \max$	1000 h
High Temperature Life Test	105 °C, DC Derating, $I_F = \max$	1000 h
Low Temperature Life Test	-40 °C, DC 1900 mA	1000 h
High Temperature Storage	120 °C	1000 h
Low Temperature Storage	-40 °C	1000 h
Thermal Shock	-45 °C / 15 min ↔ 125 °C / 15 min temperature change in 5 min	200 cycles
Temperature Cycle On/Off Test	-40 °C / 85 °C each 20 min, 100 min transfer power on/off each 5 min, DC 1080 mA	100 cycles
Temperature Humidity Storage Test	-10 °C ↔ 25 °C, 95 % RH ↔ 85 °C, 95 % RH (24 h / cycle)	100 cycles
ESD (HBM)	R ₁ : 10 MΩ R ₂ : 1.5 kΩ C: 100 pF V: ±2 kV	5 times
ESD (MM)	R ₁ : 10 MΩ R ₂ : 0 kΩ C: 200 pF V: ±0.5 kV	5 times
Vibration Test	20 ~ 80 Hz (displacement: 0.06 inch, max. 20 g) 80 ~ 2 kHz (max. 20 g) min. frequency ↔ max. frequency 4 min transfer	4 times
Mechanical Shock Test	1500 g, 0.5 ms each of the 6 surfaces (3 axis x 2 sides)	5 times
Salt Spray Test	35 °C, 5 % salt water 8 h spray, 16 h dwell	2 cycles

b) Criteria for Judging the Damage

Item	Symbol	Test Condition ($T_c = 25\text{ °C}$)	Limit	
			Min.	Max.
Forward Voltage	V_F	$I_F = 1080\text{ mA}$	L.S.L. * 0.9	U.S.L. * 1.1
Luminous Flux	Φ_v	$I_F = 1080\text{ mA}$	L.S.L. * 0.7	U.S.L. * 1.3

6. Label Structure

a) Label Structure

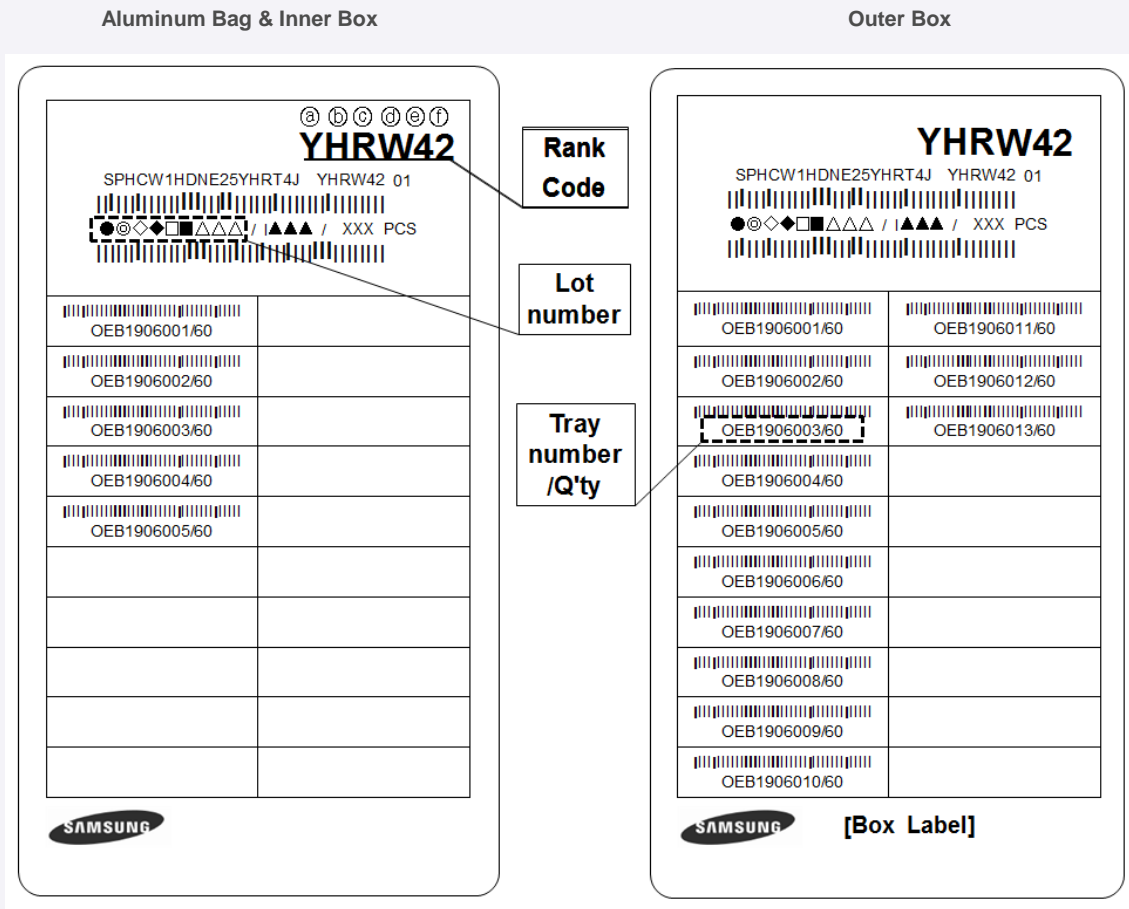

Note: Denoted rank code and product code above is only an example (see description on page 6)

Rank Code:

- ⒶⒷ: Forward Voltage rank (refer to page 7-10)
- ⒸⒹ: Chromaticity bin (refer to page 11-12)
- ⒺⒻ: Luminous Flux bin (refer to page 7-10)

b) Lot Number

The lot number is composed of the following characters:

●◎◇◆□■△△△ / 1▲▲▲ / xxx PCS

- : Production site (S: Giheung, Korea, G: Tianjin, China)
- ◎ : L (LED)
- ◇ : Product state (A: Normal, B: Bulk, C: First Production, R: Reproduction, S: Sample)
- ◆ : Year (Y: 2014, Z: 2015, A: 2016, ...)
- : Month (1~9, A, B, C)
- : Day (1~9, A, B~V)
- △△△ : Product serial number (001 ~ 009)
- ▲▲▲ : Tray number (001 ~ 999)

7. Packing Structure

Packing material	Max. quantity in pcs of COB	Dimension (mm)			
		Length	Width	Height	Tolerance
Tray	40	322.6	135.9	10.8	1.0
Aluminum Bag	320 (8 trays)	450	230	-	10
PE Foam Pad	-	280	130	10	2
Inner Box	320 (1 aluminum bag)	338	148	55	2
Outer Box	1,280 (4 inner boxes)	351	308	120	5
Pallet	71,680 (56 outer boxes)	1000	1000	130	10

a) Packing Structure

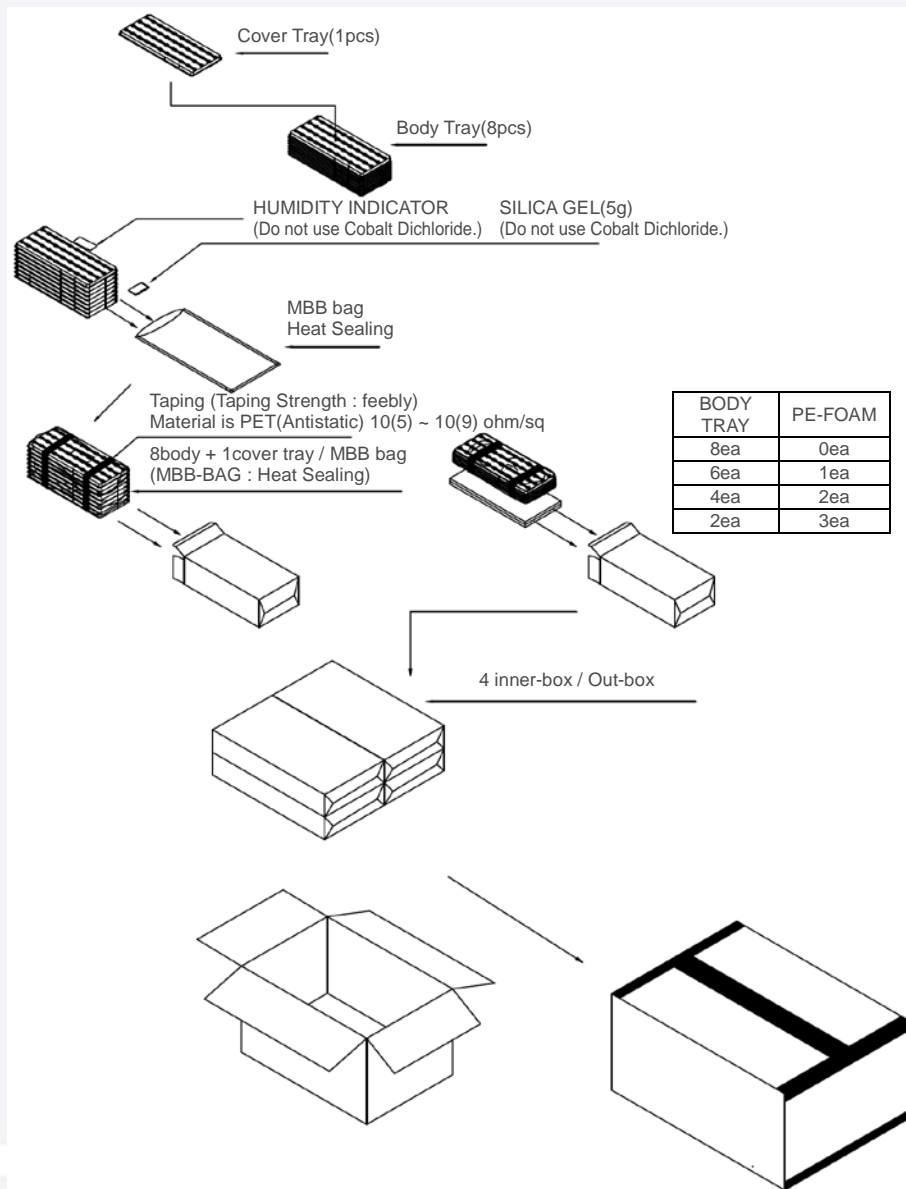

b) Tray

① COVER

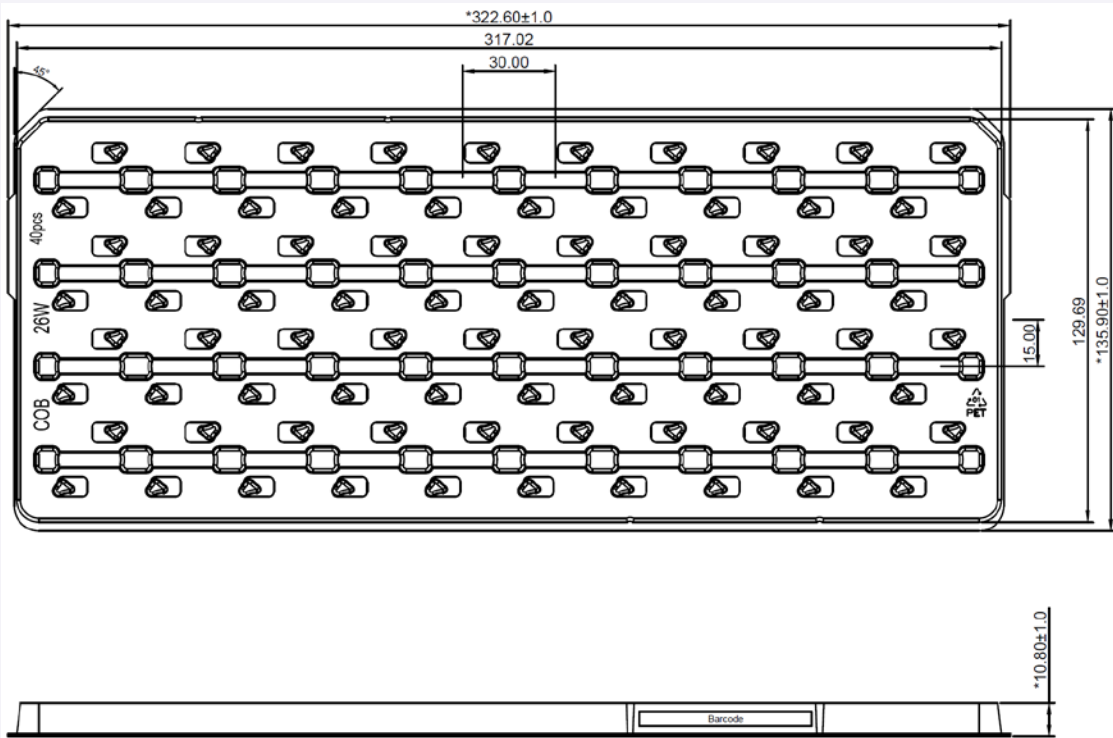

② BODY

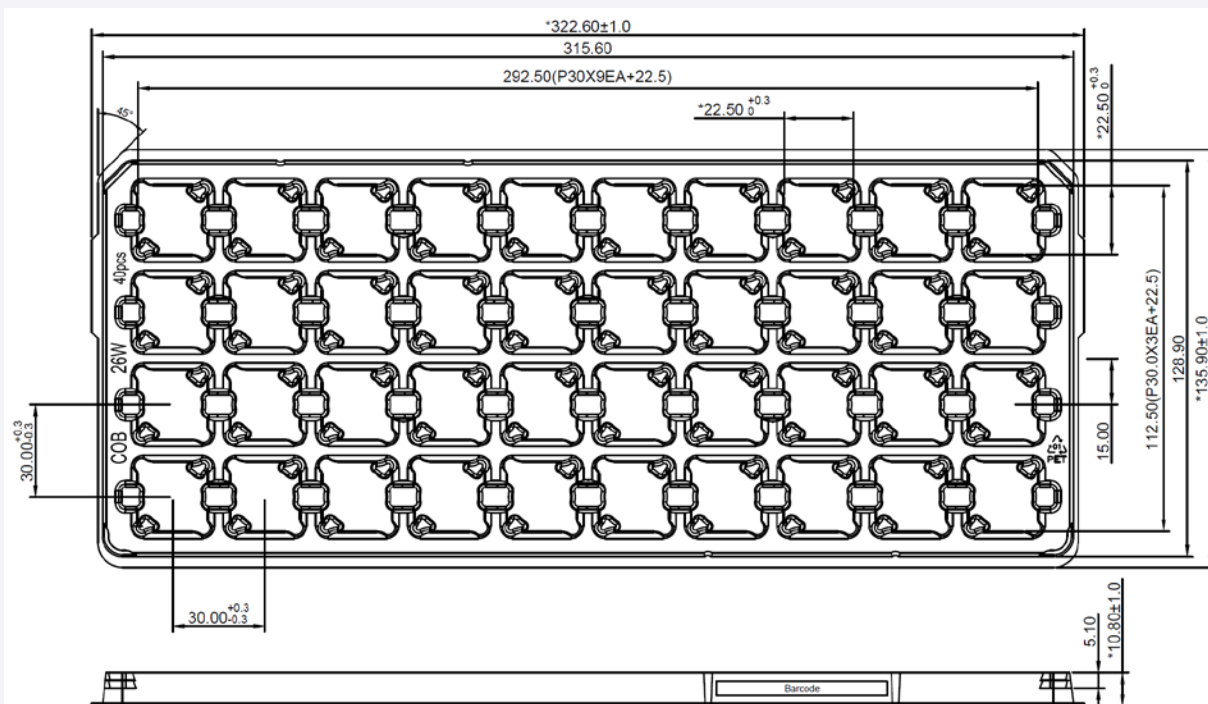

c) Aluminum Vinyl Packing Bag

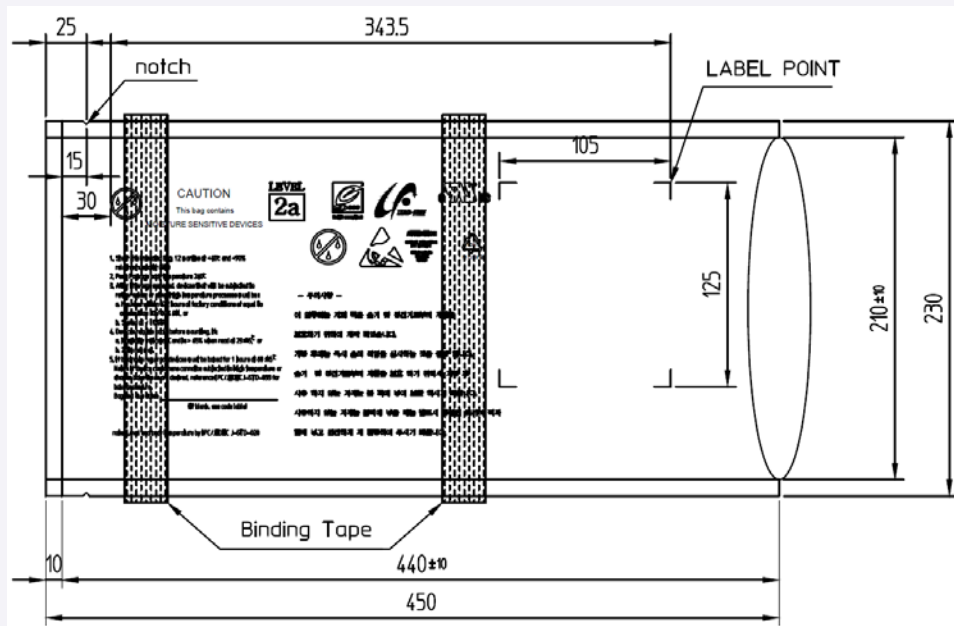

d) Silica Gel & Humidity Indicator Card inside Aluminum Vinyl Packing Bag

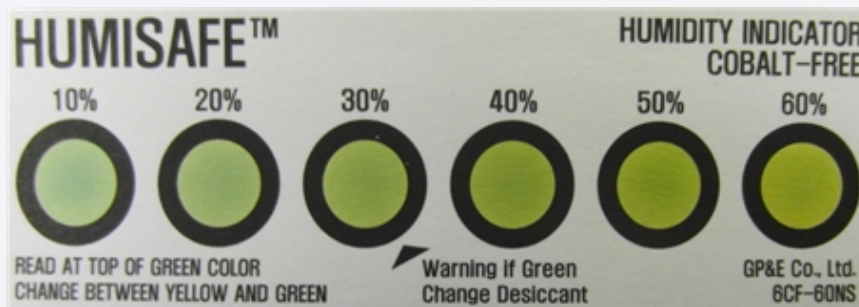

8. Precautions in Handling & Use

- 1) This device should not be used in any type of fluid such as water, oil, organic solvent, etc. When cleaning is required, IPA is recommended as the cleaning agent. Some solvent-based cleaning agent may damage the silicone resins used in the device.
- 2) LEDs must be stored in a clean environment. If the LEDs are to be stored for three months or more after being shipped from Samsung, they should be packed with a nitrogen-filled container (shelf life of sealed bags is 12 months at temperature 0~40 °C, 0~90 % RH).
- 3) After storage bag is opened, device subjected to soldering, solder reflow, or other high temperature processes must be:
 - a. Mounted within 672 hours (28 days) at an assembly line with a condition of no more than 30 °C / 60 % RH, or
 - b. Stored at <10 % RH
- 4) Repack unused products with anti-moisture packing, fold to close any opening and then store in a dry place.
- 5) Devices require baking before mounting, if humidity card reading is >60 % at 23 ± 5 °C.
- 6) Devices must be baked for 1 hour at 60 ± 5 °C, if baking is required.
- 7) The LEDs are sensitive to the static electricity and surge current. It is recommended to use a wrist band or anti-electrostatic glove when handling the LEDs. If voltage exceeding the absolute maximum rating is applied to LEDs, it may cause damage or even destruction to LED devices. Damaged LEDs may show some unusual characteristics such as increase in leakage current, lowered turn-on voltage, or abnormal lighting of LEDs at low current.
- 8) VOCs (Volatile Organic Compounds) can be generated from adhesives, flux, hardener or organic additives used in luminaires (fixtures). Transparent LED silicone encapsulant is permeable to those chemicals and they may lead to a discoloration of encapsulant when they exposed to heat or light. This phenomenon can cause a significant loss of light emitted (output) from the luminaires. In order to prevent these problems, we recommend users to know the physical properties of materials used in luminaires and they must be carefully selected.
- 9) The resin area is very sensitive, please do not handle, press, touch, rub, clean, or pick by with tweezers on it. Instead, please pick at the handling area as indicated below.

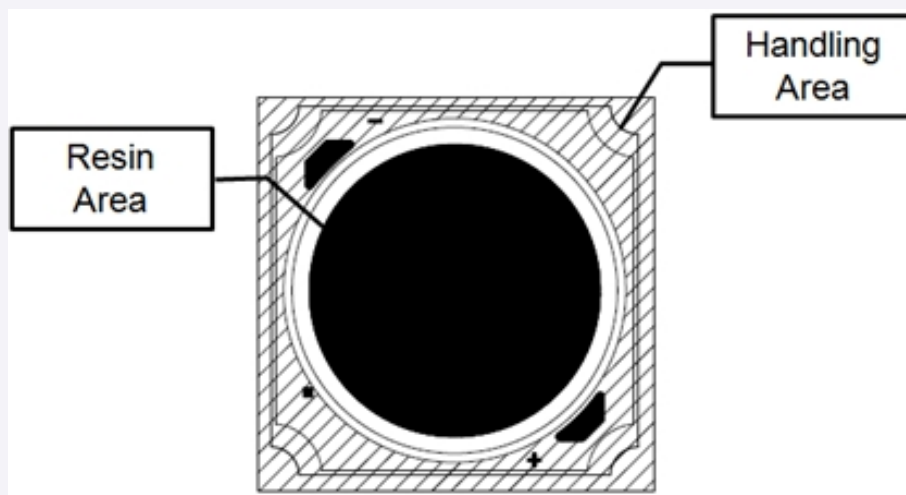

Legal and additional information.

[About Samsung Electronics Co., Ltd.](#)

Samsung Electronics Co., Ltd. inspires the world and shapes the future with transformative ideas and technologies, redefining the worlds of TVs, smartphones, wearable devices, tablets, cameras, digital appliances, printers, medical equipment, network systems and semiconductors.

We are also leading in the Internet of Things space through, among others, our Digital Health and Smart Home initiatives. We employ 307,000 people across 84 countries. To discover more, please visit our official website at www.samsung.com and our official blog at global.samsungtomorrow.com.

Copyright © 2015 Samsung Electronics Co., Ltd. All rights reserved.

Samsung is a registered trademark of Samsung Electronics Co., Ltd.

Specifications and designs are subject to change without notice. Non-metric weights and measurements are approximate. All data were deemed correct at time of creation. Samsung is not liable for errors or omissions. All brand, product, service names and logos are trademarks and/or registered trademarks of their respective owners and are hereby recognized and acknowledged.

Samsung Electronics Co., Ltd.

95, Samsung 2-ro

Giheung-gu

Yongin-si, Gyeonggi-do, 446-711

KOREA

www.samsungled.com

